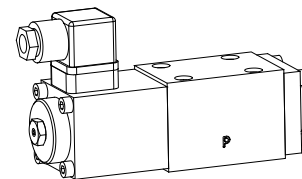

**Proportional directional valve**
**• not pressure compensated**

- $Q_{max} = 40 \text{ l/min}$
- $Q_{Nmax} = 32 \text{ l/min}$
- $p_{max} = 350 \text{ bar}$

**NG6**  
 ISO 4401-03

**DESCRIPTION**

Direct operated proportional spool valve in flange design NG6 acc. to ISO 4401-03/7790 with 4 ports. The spool valve is designed to the 5 chamber principle. The volume flow is adjusted by a Wandfluh proportional solenoid (VDE standard 0580). Low pressure drop due to the body design and spool profiling. The spool is made of hardened steel. The body made of high grade hydraulic casting for long service life is painted. The solenoid is zinc coated.

**FUNCTION**

Proportionally to the solenoid current spool stroke, spool opening and valve volume flow will increase. Proportional directional valves NG6 are not load-compensated. The optimum spool shape and progressive characteristics curve allow fine motion control. To control the valve Wandfluh proportional amplifiers are available (see register 1.13).

**APPLICATION**

Proportional directional spool valves are well suited for demanding applications where high resolution, high volume flow and low hysteresis are requested. They are implemented in industrial hydraulics as well as in mobile hydraulics for the smooth control of hydraulic actuators. Application examples: pitch control of wind generators, forest and earth moving machines, machine tools and paper production machines with simple position controls, robotics and fan control.

**CONTENT**

GENERAL SPECIFICATIONS.....	1
HYDRAULIC SPECIFICATIONS .....	1
ELECTRICAL SPECIFICATIONS.....	1
TYPE CHARTS/ DESIGNATIONS OF SYMBOLS .....	2
CHARACTERISTICS.....	2
DIMENSIONS.....	3
PARTS LIST .....	3
ACCESSORIES.....	3

**TYPE CODE**

		WDP F A06 - <input type="checkbox"/> - <input type="checkbox"/> - <input type="checkbox"/> - <input type="checkbox"/> # <input type="checkbox"/>
Proportional directional valve		
Flange construction		
International standard interface ISO, nominal size 6		
Description of symbols acc. to table 1.10-75/2		
Nominal volume flow $Q_N$ :	5 l/min	<input type="checkbox"/> 5
	10 l/min	<input type="checkbox"/> 10
	16 l/min	<input type="checkbox"/> 16
	32 l/min	<input type="checkbox"/> 32
Standard nominal voltage $U_N$ :	12 VDC	<input type="checkbox"/> G12
	24 VDC	<input type="checkbox"/> G24
Design-Index (Subject to change)		

**GENERAL SPECIFICATIONS**

Nominal size	NG6 acc. to ISO 4401-03/7790
Designation	4/2-, 4/3-way proportional directional valve
Construction	Direct operated spool valve
Mounting	Flange, 4 fixing holes for socket head cap screws M5x50
Fastening torque	$M_D = 5,5 \text{ Nm}$ (screw qual. 8.8)
Pipe connection	Connection plates Multi-station flange subplate Longitudinal stacking system
Mounting position	any, preferably horizontal
Ambient temperature	-20...+50 °C
Weight: 4/2-way	m = 2,0 kg
4/3-way	m = 2,5 kg

**HYDRAULIC SPECIFICATIONS**

Fluid	Mineral oil, other fluid on request
Contamination efficiency	ISO 4406:1999, class 18/16/13 (Required filtration grade $\beta_{6...10} \geq 75$ ) refer to data sheet 1.0-50/2
Viscosity range	12 mm <sup>2</sup> /s...320 mm <sup>2</sup> /s
Fluid temperature	-20...+70 °C
Working pressure	$p_{max} = 350 \text{ bar}$ (connections P, A, B)
Tank pressure	$p_{max} = 160 \text{ bar}$ (connection T)
Nominal volume flow	$Q_N = 5 \text{ l/min}, 10 \text{ l/min}, 16 \text{ l/min}, 32 \text{ l/min}$
Max. volume flow	see characteristic
Leakage volume flow	on request
Hysteresis	$\leq 5\% *$ * at optimal dither signal

**ELECTRICAL SPECIFICATIONS**

Construction	Proportional solenoid, wet pin push type, pressure tight	
Standard-Nominal voltage	U = 12 VDC	U = 24 VDC
Limiting current	$I_G = 1780 \text{ mA}$	$I_G = 810 \text{ mA}$
Relative duty factor	100% DF (see data sheet 1.1-430)	
Protection class	IP 65 acc. to EN 60529	
Connection/Power supply	Over device plug connection acc. to ISO 4400/DIN 43650 (2P+E)	
Other electrical specifications	see data sheet 1.1-130 (PI45V)	

## TYPE CHARTS / DESIGNATIONS OF SYMBOLS

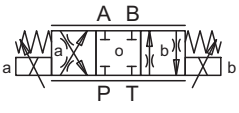
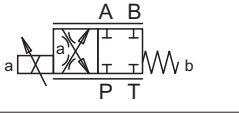
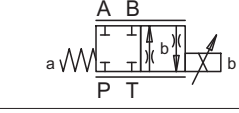
	<b>ACB - S</b> S = Symmetrical control mode
	<b>AC1 - S</b> S = Symmetrical control mode
	<b>CB2 - S</b> S = Symmetrical control mode

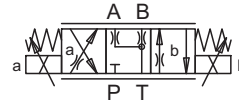
	<b>ADB - V</b> V = Meter-in control mode
--	---

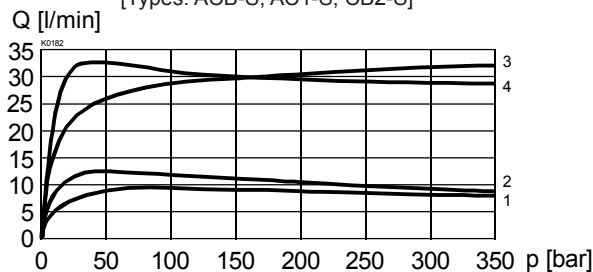
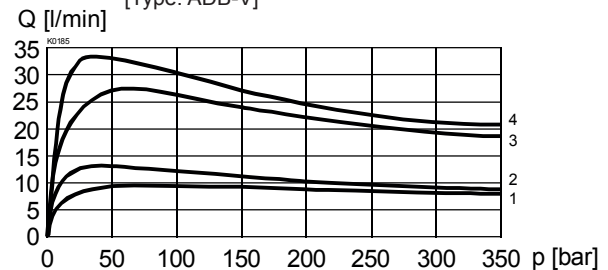
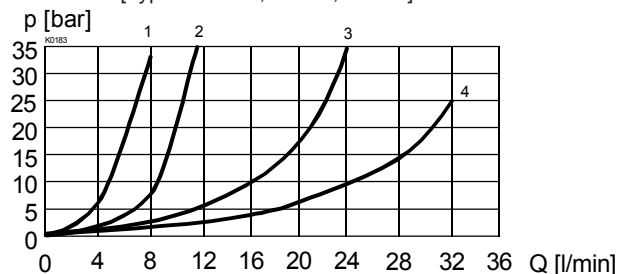
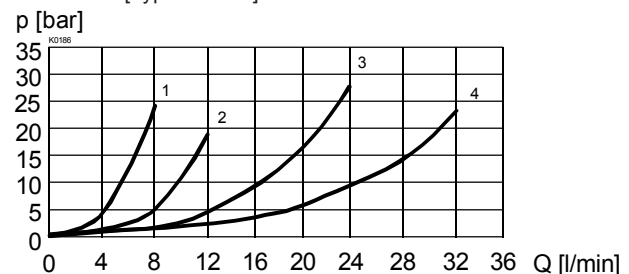
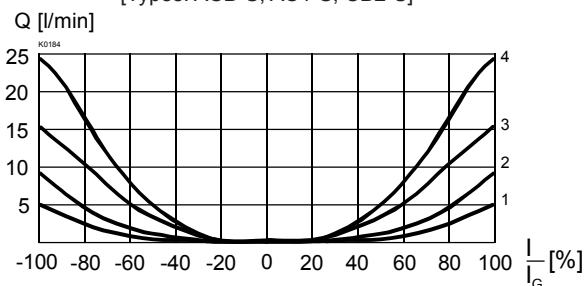
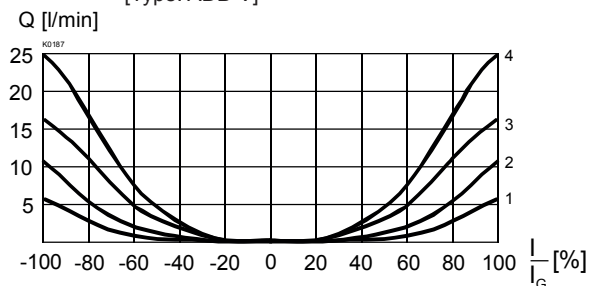
**CHARACTERISTICS** oil viscosity  $\nu = 30 \text{ mm}^2/\text{s}$ 
 $Q = f(p)$  Volume flow pressure characteristics ( $l = l_0$ )  
 [Types: ACB-S, AC1-S, CB2-S]

 $Q = f(p)$  Volume flow pressure characteristics ( $l = l_0$ )  
 [Type: ADB-V]

 $\Delta p = f(Q)$  Pressure loss/flow characteristics ( $l = l_0$ )  
 [Types: ACB-S, AC1-S, CB2-S]

 $\Delta p = f(Q)$  Pressure loss/flow characteristics ( $l = l_0$ )  
 [Type: ADB-V]

 $Q = f(l)$  Volume flow adjustment characteristics ( $\Delta p = 10 \text{ bar}$ )  
 [Types: ACB-S, AC1-S, CB2-S]

 $Q = f(l)$  Volume flow adjustment characteristics ( $\Delta p = 10 \text{ bar}$ )  
 [Type: ADB-V]

**Legend:**

- 1:  $Q_N = 5 \text{ l/min}$       3:  $Q_N = 16 \text{ l/min}$   
 2:  $Q_N = 10 \text{ l/min}$     4:  $Q_N = 32 \text{ l/min}$

**NOTE!**

All values measured over 2 metering edges, A and B ports linked

**DIMENSIONS**

4/3-way valve

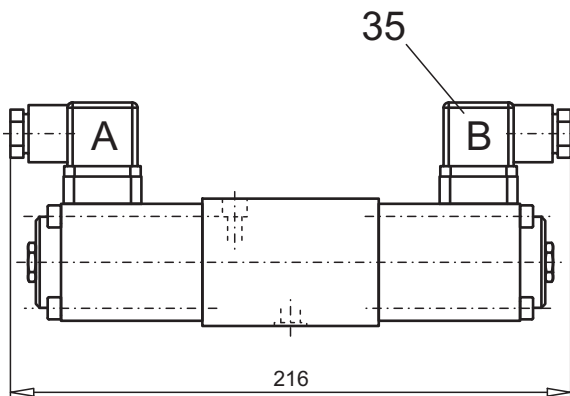

4/2-way valve

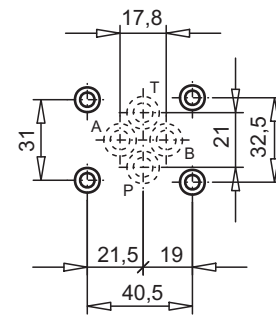
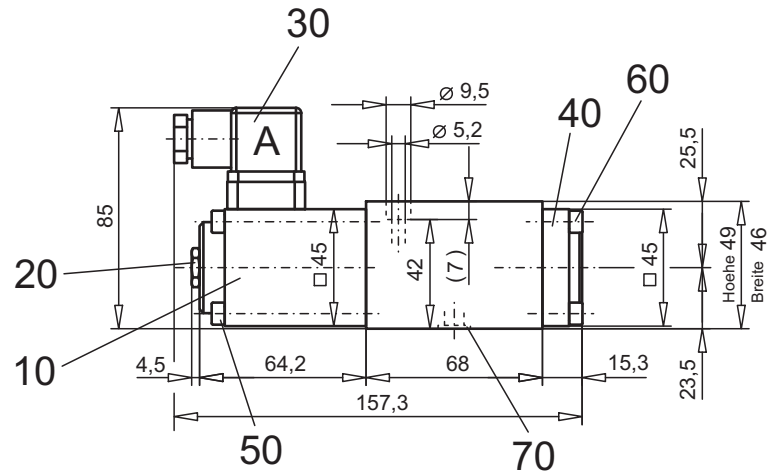
**PARTS LIST**

Position	Article	Description
10	256.4454 256.4418	Proportional solenoid PI45V-G24 Proportional solenoid PI45V-G12
20	253.8001	Plug with integrated manual override HB6
30	219.2001	Plug A (grey)
35	219.2002	Plug B (black)
40	058.4211	Cover
50	246.2160	Socket head cap screw M5x60 DIN 912
60	246.2117	Socket head cap screw M5x16 DIN 912
70	160.2093	O-ring ID 9,25 x 1,78

**ACCESSORIES**

 Sub-plates  
 Proportional-amplifier

 Register 2.9  
 Register 1.13

Technical explanation see data sheet 1.0-100